

Article number: 2310320103  
Description: E+G Square end-cap  
NDX.Q-40x2.5-M12

## Measures

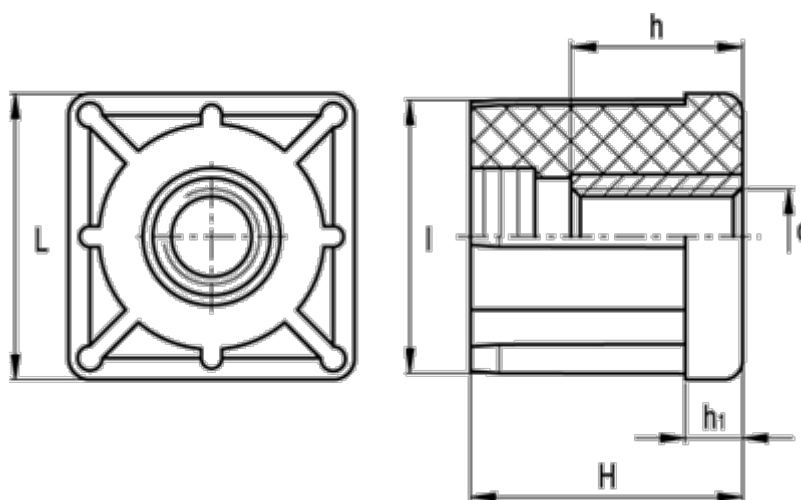

d	= M12	Tube wall thickness = 2.5
h	= 10	Weight (g) = 47
H	= 38	
h1	= 8	
Internal tube size	= 35.0	
l	= 35.0	
L	= 40	
Outer tube size	= 40	